

# Linearis – ensuring premium quality

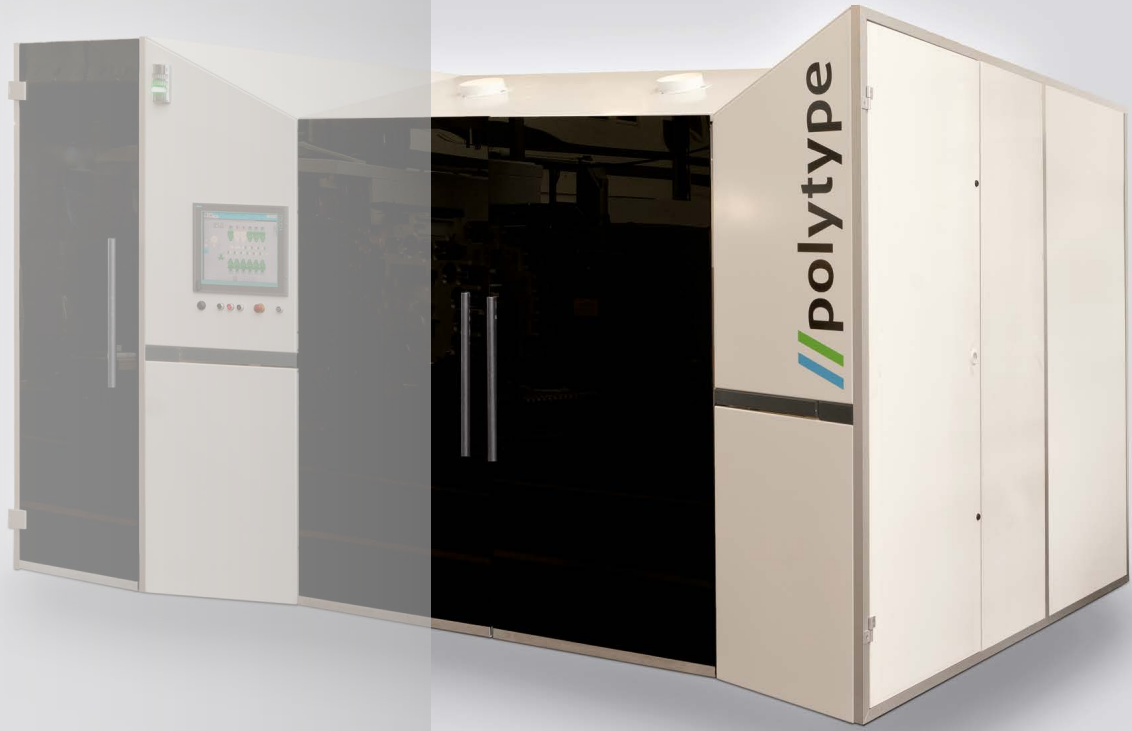

The flexible multi-decoration and varnishing machine for plastic sleeves

# Developed to meet the toughest demands



Combinations of ...

- 1 flexo print, screen print and glossy varnish
- 2 process offset print and matt varnish
- 3 hot stamping, process offset, screen print and glossy varnish
- 4 flexo print, screen print and glossy varnish
- 5 hot stamping, process offset, flexo, screen print and glossy varnish
- 6 hot stamping, flexo print, screen print and glossy varnish

//polytype is the leading manufacturer of premium quality decorating and finishing machines for plastic tubes and sleeves. Customers benefit from the best solutions with optimum performance and high flexibility. Polytype AG is part of the wifag//polytype Group, allowing us to benefit from a broad technology base.

When you choose //polytype linearis, you get maximum flexibility in a single machine. This is true regardless of whether you are decorating a tube using screen and process offset printing or hot stamping plus flexo and screen printing, or a sleeve using matt varnishing and screen printing. And it also doesn't depend on the processes you use or the sequence you perform them in.

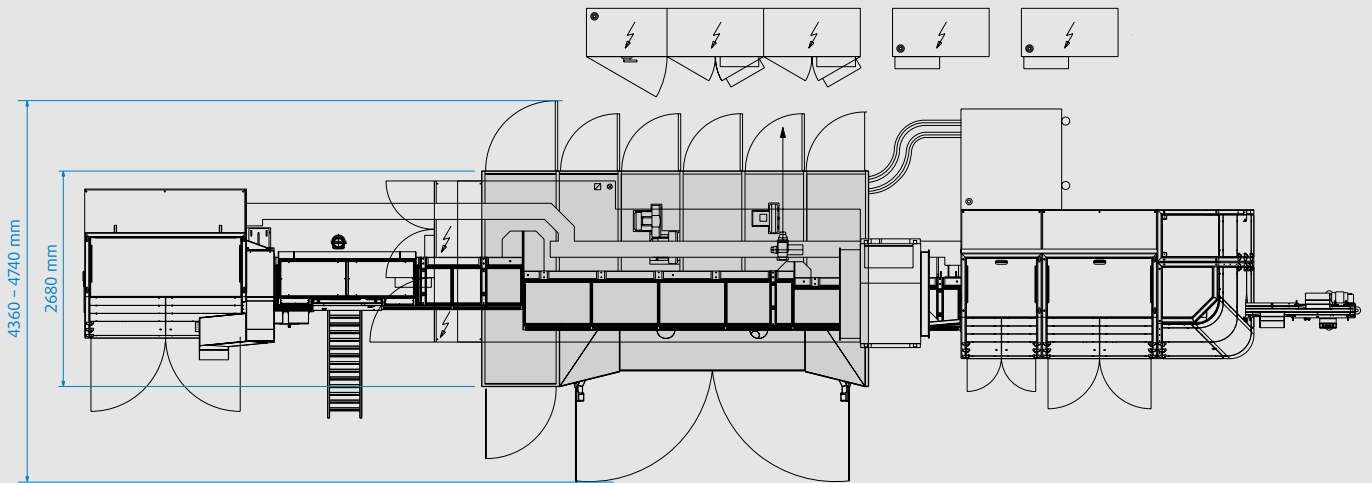
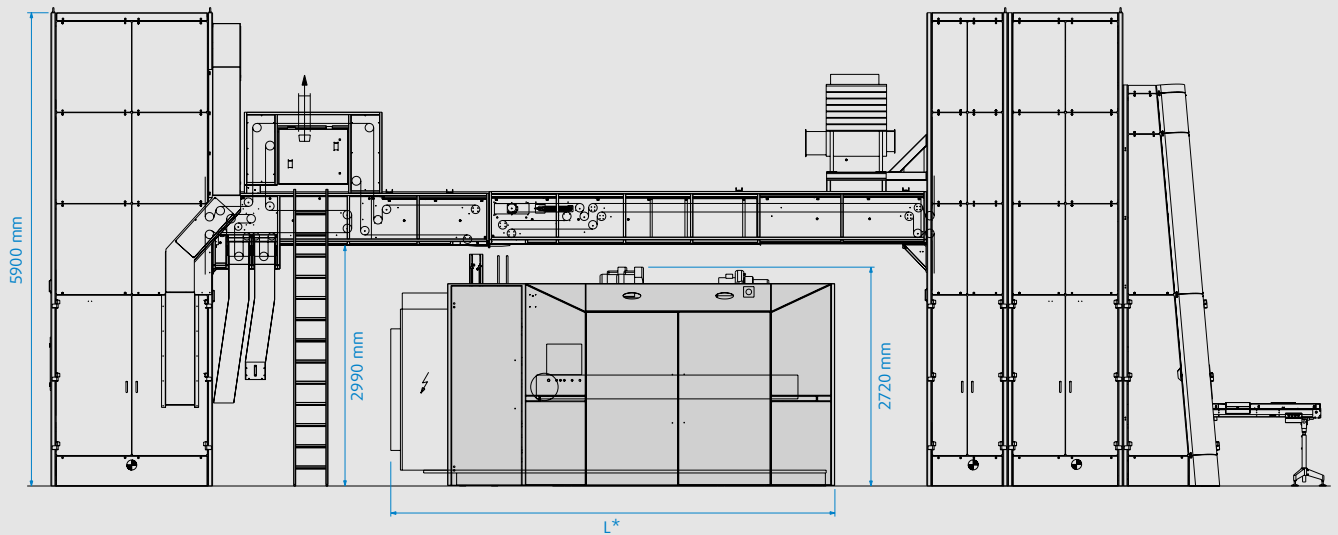

### Further possibilities

- // Print inspection with a visual control system
- // Lacquer viscosity control system for a higher matt varnish quality

### Training

Learn more about flexo and screen printing processes and hot stamping on //polytype linearis machines. Find out how you can get the most out of your machine in our individually tailored basic and advanced courses.

#### Technical data

	Linearis 4 segments	Linearis 6 segments
Min./max. diameter:	19-60 mm	19-60 mm
Skirt length:	60-210 mm	60-210 mm
Max. printing width:	205 mm	205 mm
Max. mech. operating speed:	130 pcs./min	130 pcs./min
Max. production speed:	120 pcs./min	120 pcs./min
Number of decoration stations:	8	12
Number of UV lamps:	8+1	10 or 12+1
Approx. length of machine L*:	4750 mm	5520 mm
Approx. weight of machine:	15 T	18 T

# Combination of varieties at its finest

## Loading

//polytype linearis offers high process stability for transferring tubes from the transport chain to the mandrels. The take-off drum operates using vacuum trays and vacuum star prisms.



## Cleaning

Sleeves are cleaned using ionization with dust removal.

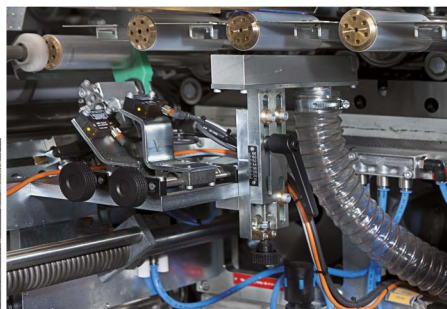

## Surface pre-treatment

The //polytype gas flame or corona pre-treatment ensure optimum surface pre-treatment.

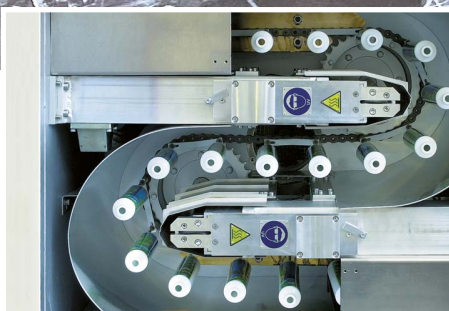
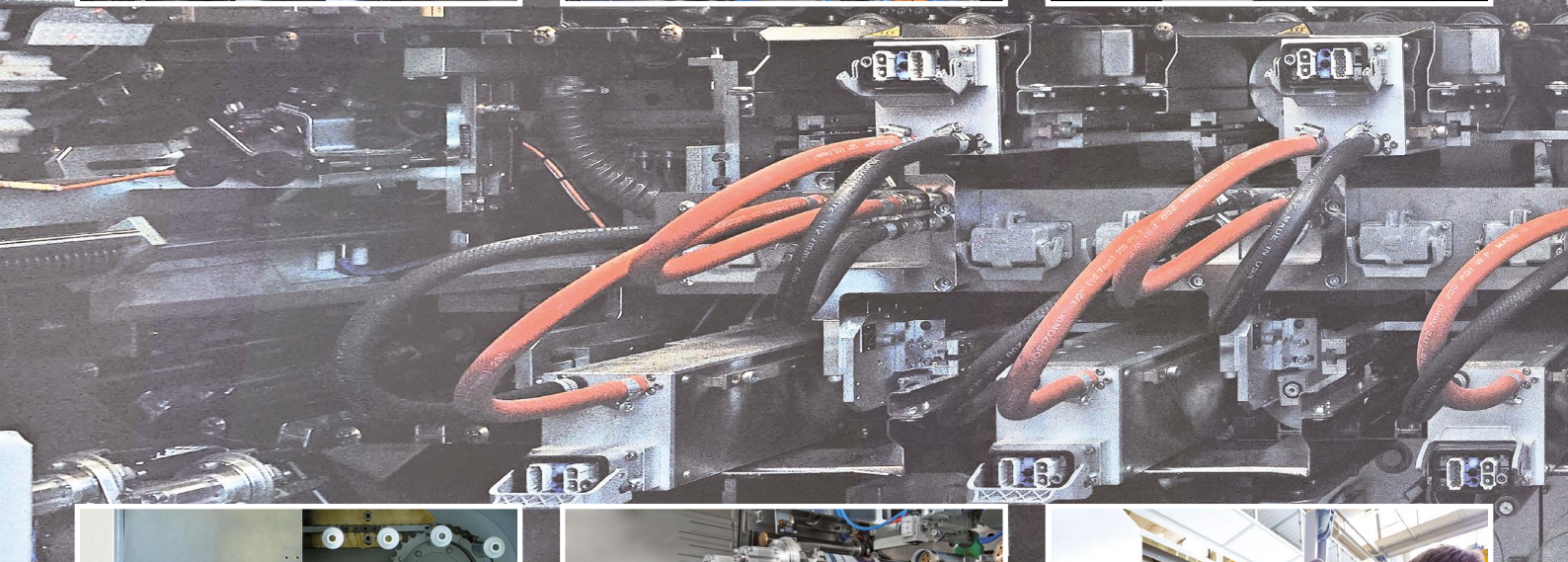

## Lacquer curing

A separate //polytype UV oven is used to ensure uniform lacquer curing. Its progressive power regulation is designed for premium lacquer quality.



## Unloading

//polytype linearis offers high process stability for transferring from the mandrels to the transport chain.



## Changeover

To make your production preparations more efficient, a service trolley can be used to change over printing units quickly and also set them up outside the machine.

### Process offset printing

The process offset station is equipped with an inking unit, a printing plate cylinder and a blanked cylinder. The solution for an easy color density adjustment and a stable process print.

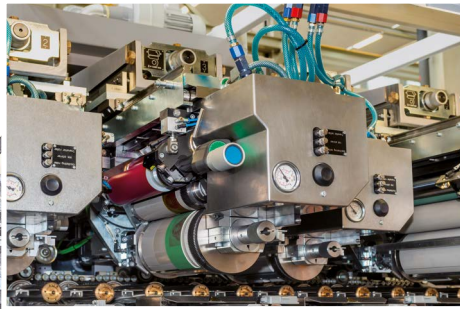

### Flexo printing

The flexo printing station is equipped with a temperature-controlled anilox roller. It is designed for quick and easy plate changes (//polytype design) and fast print adjustment inside and outside the machine.

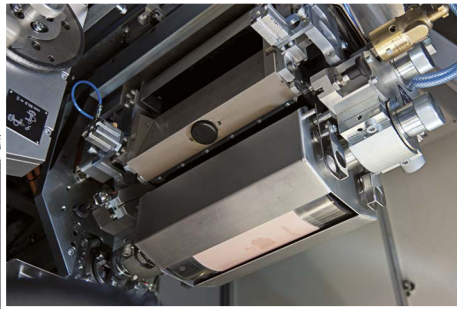

### Ink curing

UV ink curing is performed after each operation. Exchangeable, water-cooled lamps also enable overlap curing in every printing position.

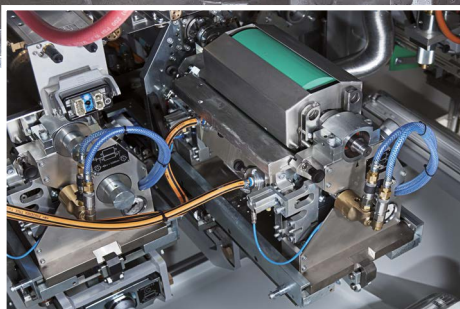
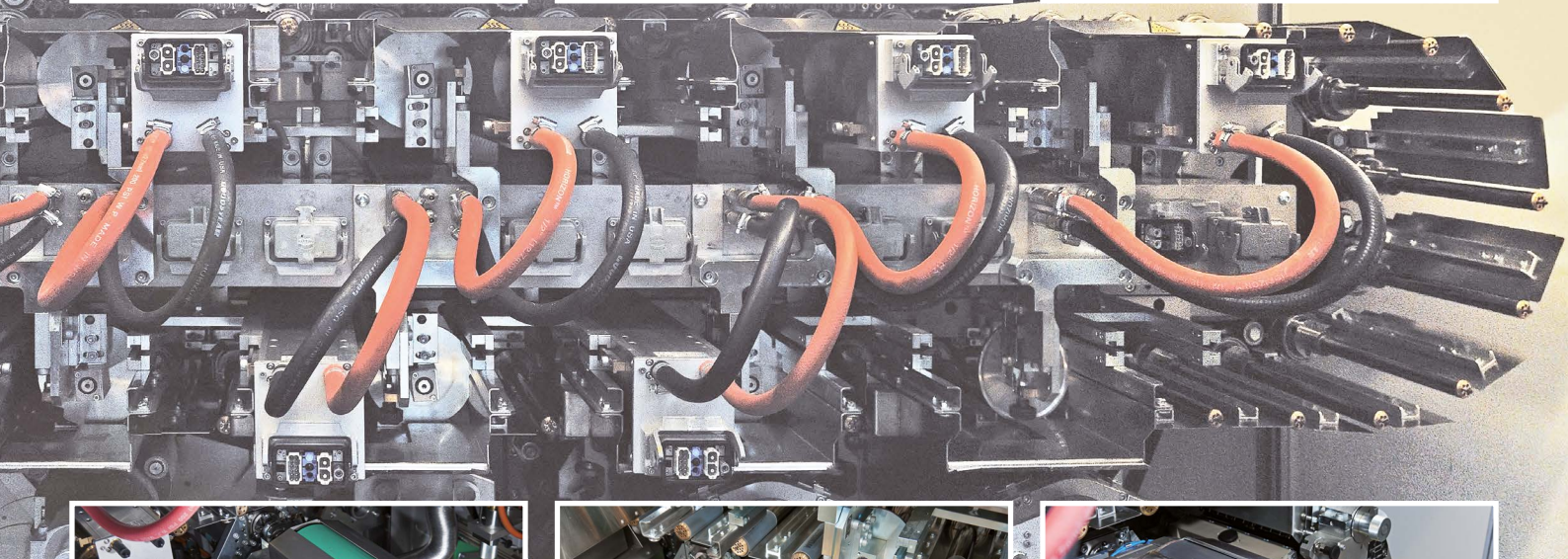
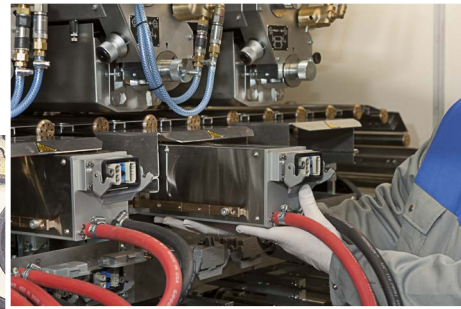

### Varnishing

The anilox roller varnishing unit can be installed at any position in the machine and ensures uniform application of glossy or matt varnishes.

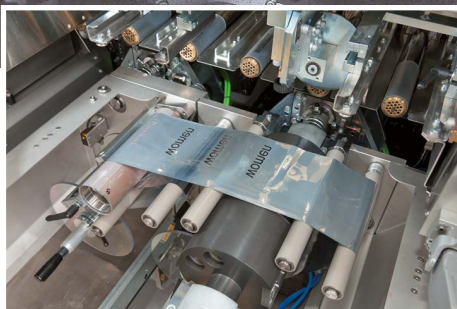

### Metallic effects

//polytype hot-stamping units deliver outstanding results in applying metallic design elements even at high speeds and can be operated either together or separately.

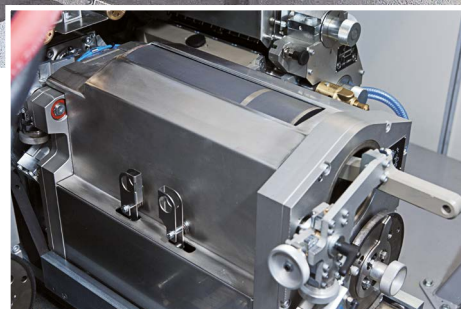

### Screen printing

The rotary screen printing station is ideal for high speeds while maintaining the highest quality. It is designed to enable fast screen changes inside and outside the machine.

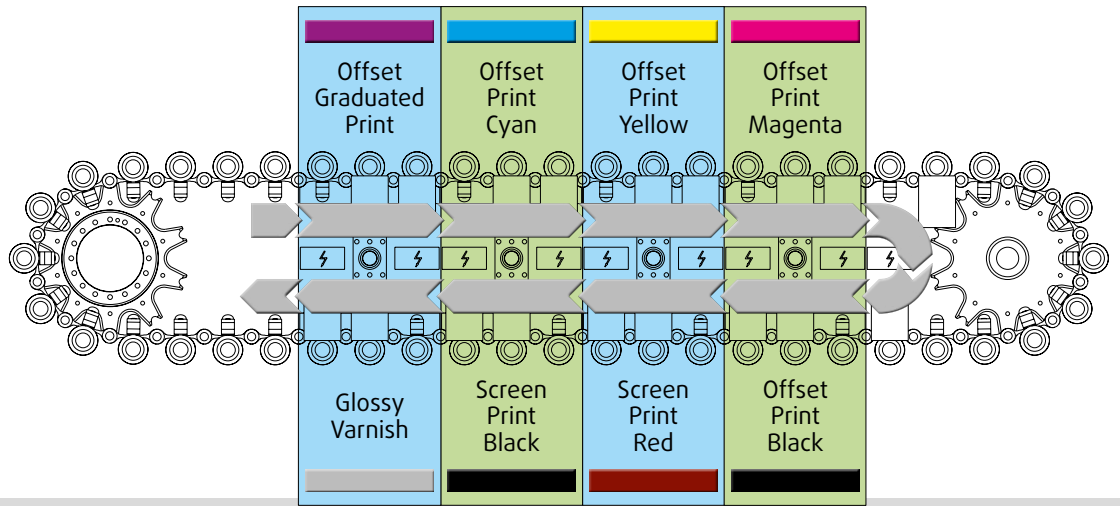

**Decoration with 4 segments and 8 modules**

Example of 7-color printing with glossy varnishing on an 8-color machine with 4 segments

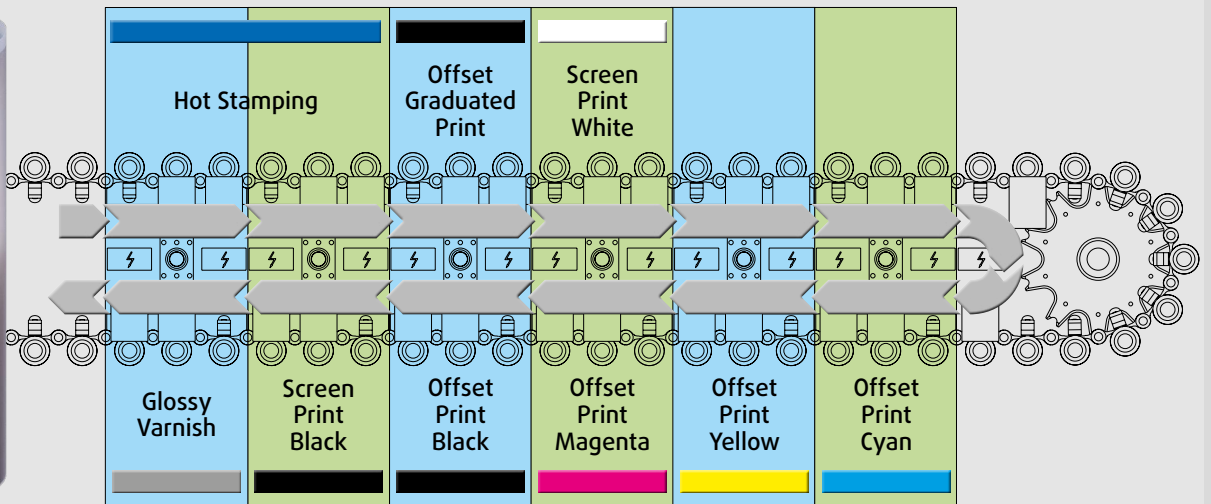

**Multi-decoration with 6 segments and 10 modules**

Example of 7-color printing plus hot stamping and varnishing on a 10-color machine with 6 segments

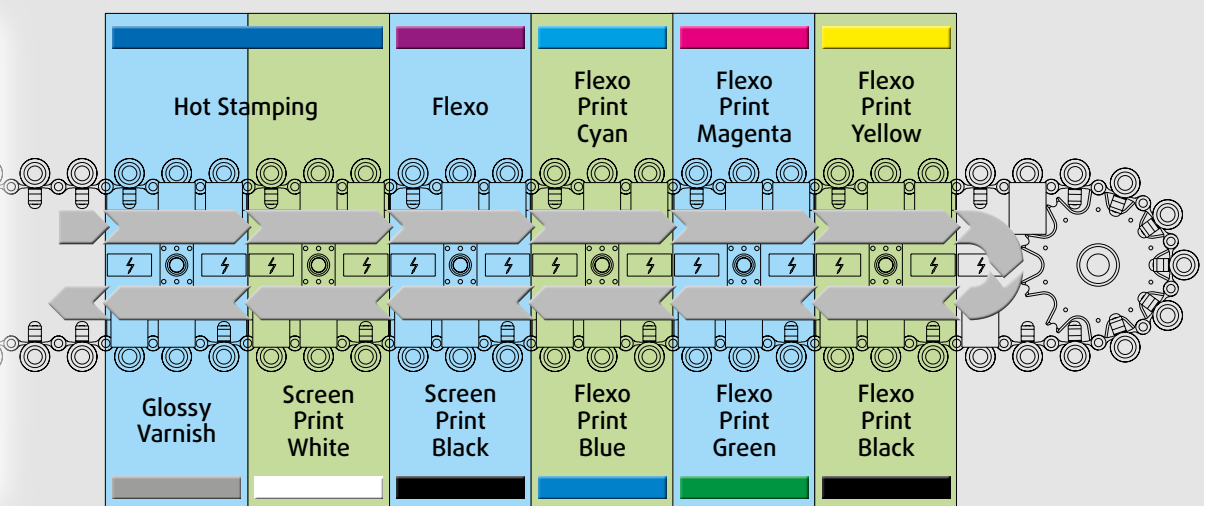

**Multi-decoration with 6 segments and 12 modules**

Example of 8-color printing plus hot stamping and varnishing on a 12-color machine with 6 segments

- // An all-in-one machine for premium-quality decoration tasks
- // High productivity through fast product changeover and short cycle time
- // Excellent cost efficiency thanks to compact design, minimal manpower requirements and low reject rates
- // Extremely wide range of decoration options
- // Decoration processes can be freely combined

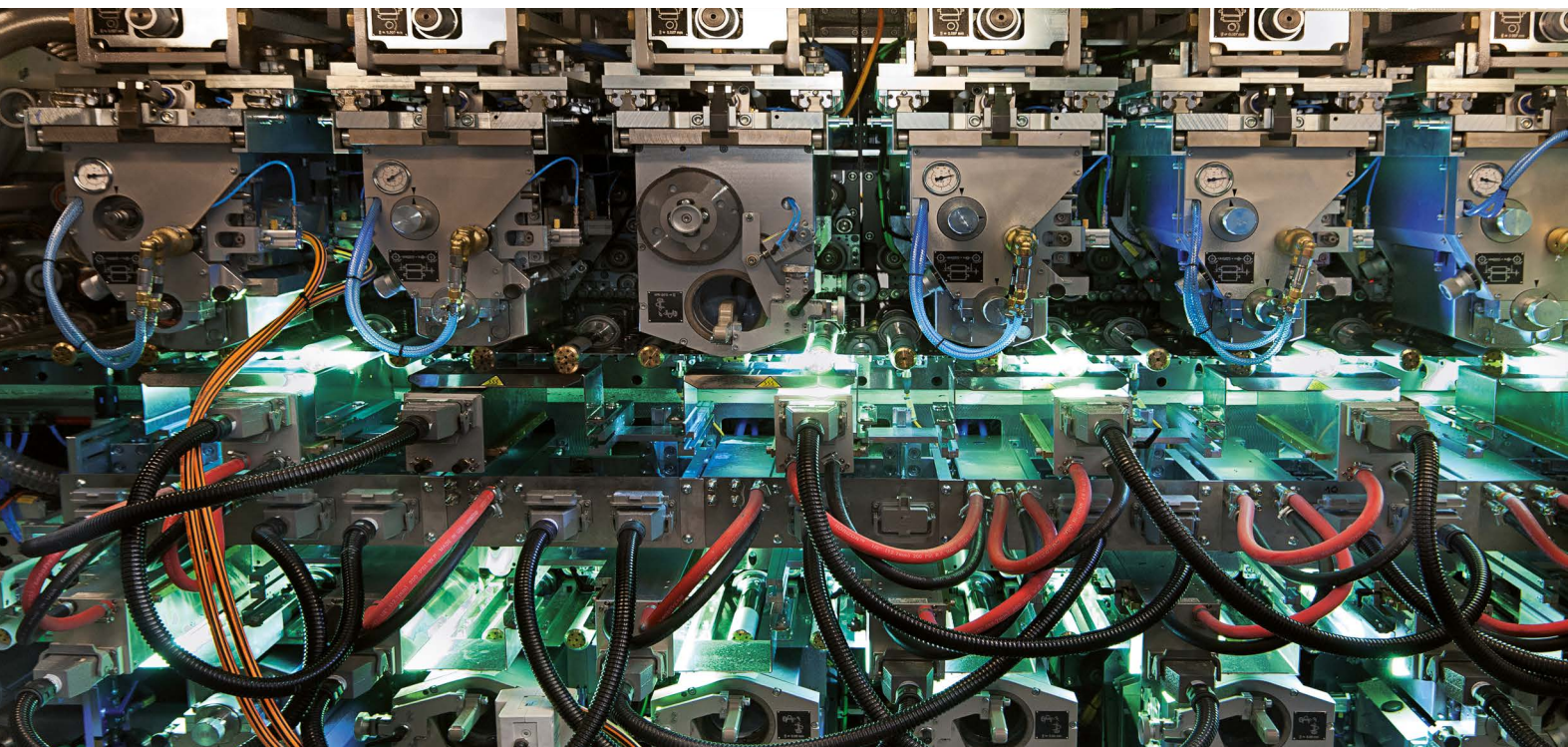

//polytype linearis is a modular machine system for decorating plastic sleeves that satisfies the most exacting quality requirements. The combination of a wide range of decoration processes and the option of freely selecting the decoration sequence enables a variety of design choices:

- // Process offset printing
- // Flexo printing
- // Rotary screen printing
- // Glossy and matt varnishes
- // Spot lacquering
- // Hot stamping
- // Options for further processes

The robust construction in combination with the modular machine concept provides the basis for high-precision and stable production of high-quality sleeves.

With //polytype linearis, you make the right decision every time. The machine is suitable for:

- // Sleeves
- // Integration into a production line or as a stand-alone unit
- // 8, 10 or 12 decoration processes
- // Customizing the combination and sequence of decoration stations in the machine

**Polytype AG**  
26, route de la Glâne  
CH-1701 Fribourg/Switzerland

Phone +41 26 426 11 11

info@polytype.com  
www.polytype.com

**SWITZERLAND**

WIFAG-Polytype Holding AG  
Fribourg/Switzerland

Polytype AG  
Fribourg/Switzerland

**AMERICA**

Polytype America Corp.  
Lincoln Park, NJ/USA

**ASIA**

Polytype Asia Pacific Co., Ltd.  
Chachoengsao/Thailand