

# BDM 482 – Outstanding offset



Dry offset printing machine for cups  
with an excellent price /performance  
ratio

# The cups of champions



The enlightened layout and ingenuitive design means minimal costs in man power and time when it comes to change over times or maintenance. The sheer accessibility of parts means that operators will bask in their own productivity and means less down time for you.

The superb, uncompromising build quality of our machines make them an investment which will pay out profits for decades to come. Choose//polytype to shape your future, today.

- // 450 cups per minute
- // 6-8 colour options
- // Swiss engineering quality with efficient operation
- // Versatile cup height, width, diameter and taper dimensions
- // Global service excellence

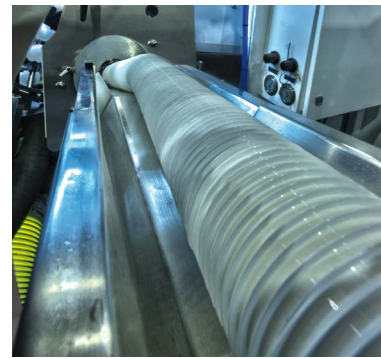
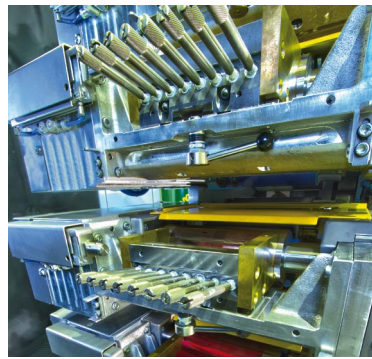
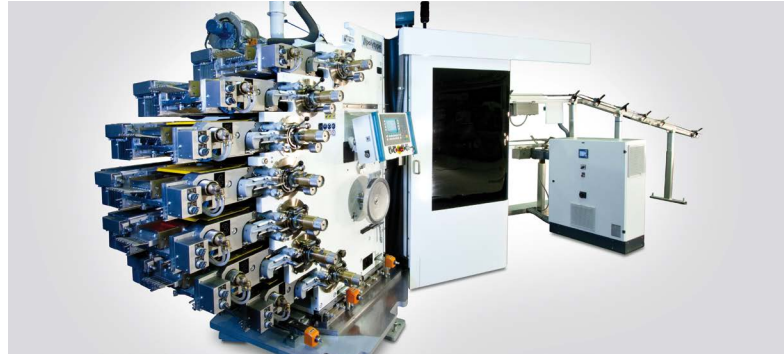

### **High Power UV Curing**

High powered UV ink curing on the mandrels for instantaneous VOC free drying. Good for both the environment and the machine operator.

### **Outstanding print quality**

Wear resistant printing/inking units with fast-fit and leak-free ink fountain system, optional cooling and agitators are designed for the highest demands and guarantee excellent print quality.

### **User friendly**

The user friendly colour touch screen user interface and intelligent single operator layout of the machine ensure easy access and operator safety. All process functions can be made while the machine is running.

### **Progressive adjustable ink metering system**

A perfectly controlled ink flow provides consistent and excellent half tone/full tone print quality which is easily controlled via the control panel.

### **Efficiency**

Quick-lock printing plate cylinders equipped with dial gauges and register micro-settings for fast job repeats. Quick change mandrels guarantee very short change-over times.

### **Versatility**

Print on cups from 30-200 mm height, 60-185 mm rim diameter and 2-15° taper with a max printing width of 145 mm. Printing lengths of 345 mm (6 segment mode) 502 mm (3 segment mode) and up to 610 mm with magnetic plate cylinders; at a speed of 450 cups per minute.

## BDM 482 – Technical data

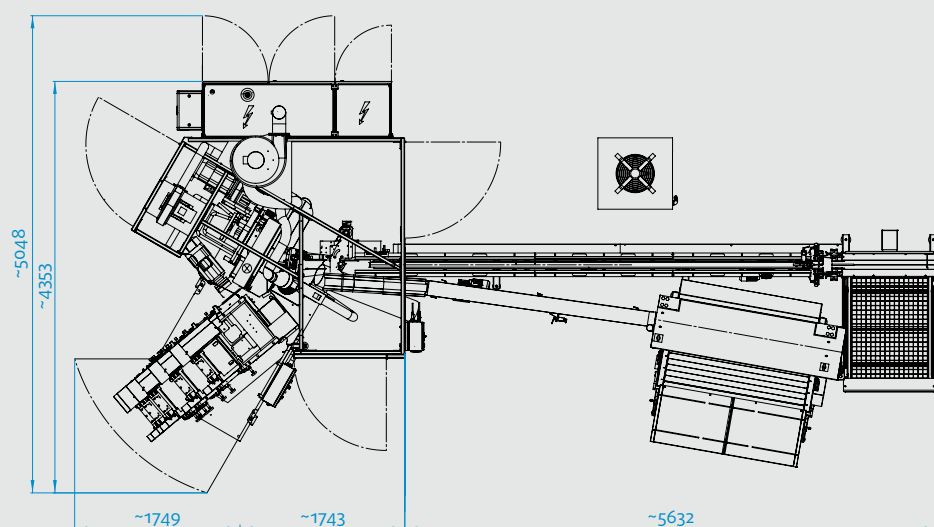
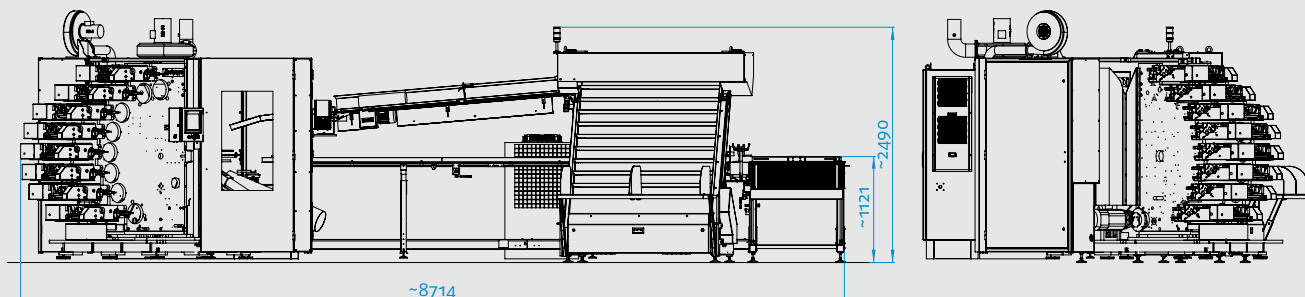

Speed:	450 cups per minute / 27,000/h
Min/Max cup height:	30–200 mm
Min/max rim diameter:	60–185 mm
Max printing width:	145 mm
Indexing angle:	160° in standard
Max printing length:	345 mm in 6 segment mode
6 sections/3 sections:	502 mm in 3 segment mode and up to 610 mm with magnetic plate cylinders
Min/max taper:	2–15°
Colors/Inking units:	6–8
Weight of machine:	6500 kg
Machine height:	2.5 m / 100 in
Machine Length:	8.1 m / 320 in (including infeed conveyor)
Machine depth:	3.4 m / 135 in
Ambient conditions:	Temperature: 10–35°C (50–95°F); humidity 20–80%
Safety:	Conforms to the highest requirements with respect to personal safety and environmental compatibility (CE conformity)

- // Best price-performance ratio
- // Swiss high quality design
- // Reliable and stable production
- // With up to 8 colours
- // State of the art technology

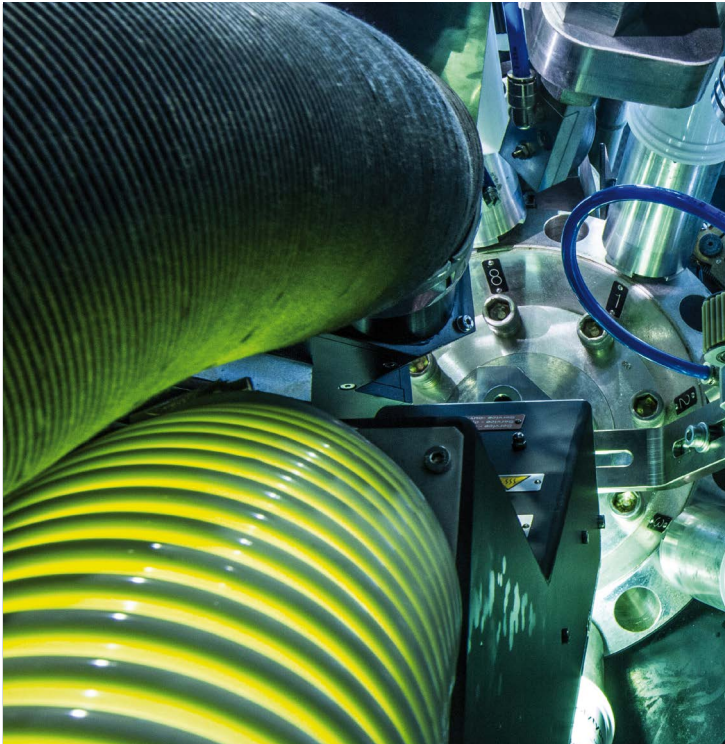

Take your business to the next level with the incredible BDM 482 offset printing machine for plastic cups. Feed your profits with 450 cups per minute and deliver 8 colour perfect registration to your clients.

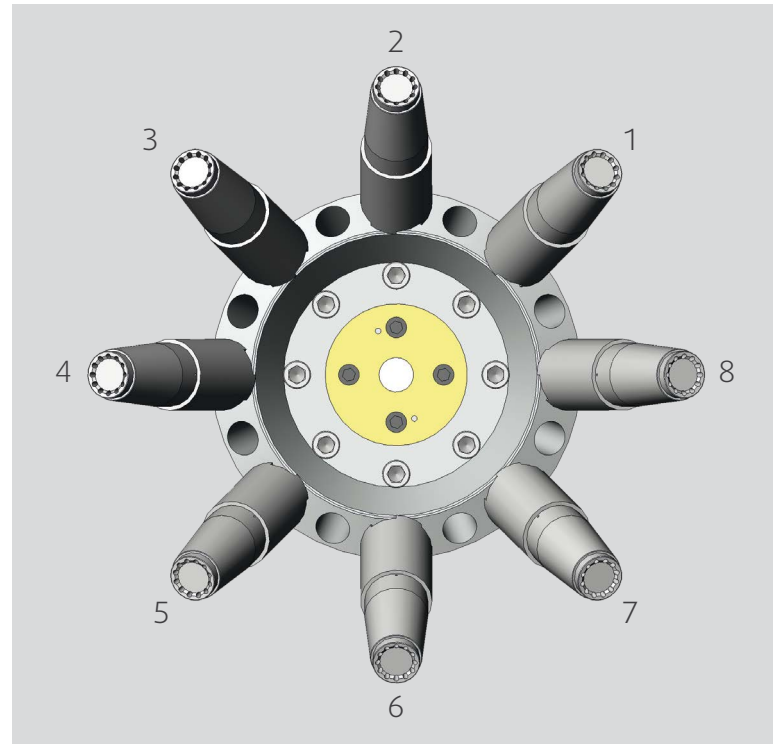

#### Station set-up for the BDM 482

- 1 - Cup loading /  
Cup & double cup presents control
- 2 - Pre-treatment by corona or gas
- 3 - Not occupied
- 4 - Printing / Option - pre-print
- 5 - Not occupied
- 6 - UV-Curing
- 7 - Ejection
- 8 - Cup take-off

**Polytype AG**  
26, route de la Glâne  
CH-1701 Fribourg/Switzerland

Phone +41 26 426 11 11

info@polytype.com  
www.polytype.com

**SWITZERLAND**

WIFAG-Polytype Holding AG  
Fribourg/Switzerland

Polytype AG  
Fribourg/Switzerland

**AMERICA**

Polytype America Corp.  
Lincoln Park, NJ/USA

**ASIA**

Polytype Asia Pacific Co., Ltd.  
Chachoengsao/Thailand